

# Automotive Small-Signal MOSFET

Explore Taiwan Semiconductor's automotive small-signal MOSFETs, designed to excel in the most rigorous automotive environments. Engineered with precision and reliability in mind, the MOSFETs offer unparalleled performance, efficiency, and robustness. From superior power management to precise control, experience the next level of automotive electronics.



Official Website X LinkedIn

For more information: [marketing@ts.com.tw](mailto:marketing@ts.com.tw)

© 2024 TAIWAN SEMICONDUCTOR, CO., LTD. ALL RIGHTS RESERVED.

## PACKAGE

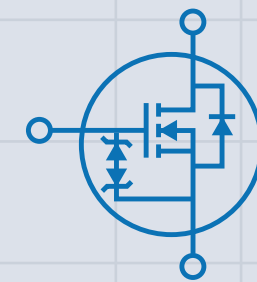
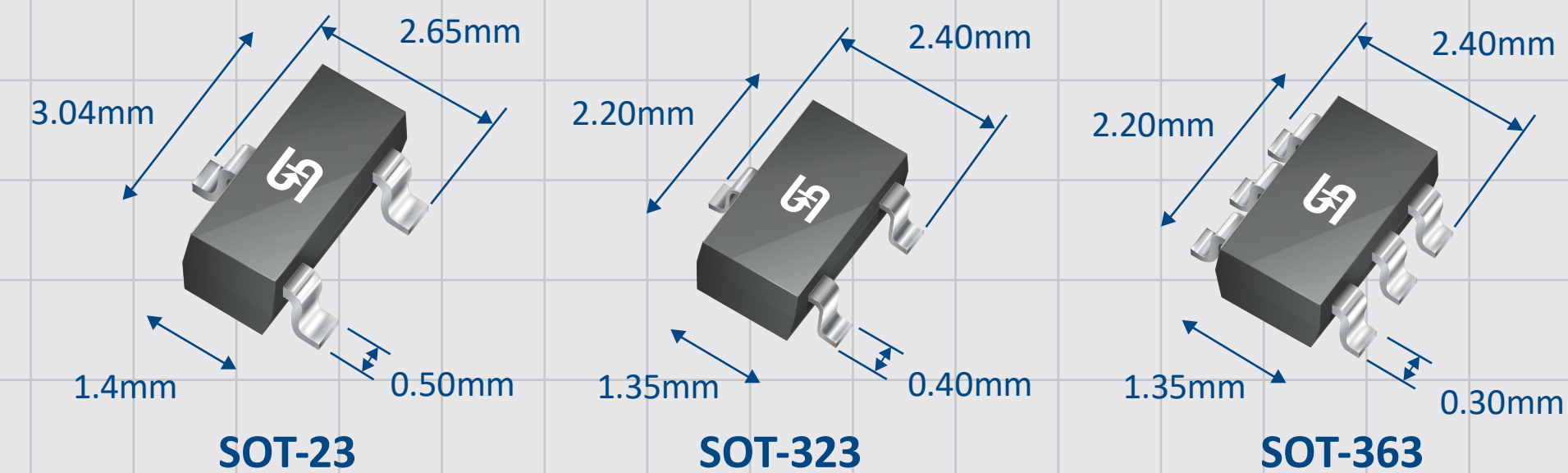

N-Channel

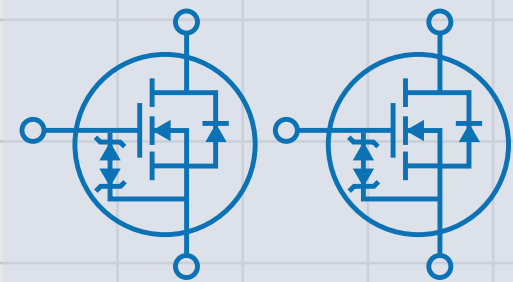

Dual N-Channel

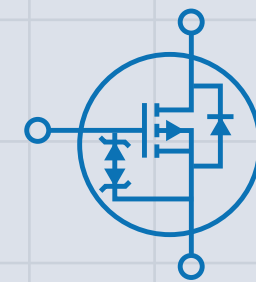

P-Channel

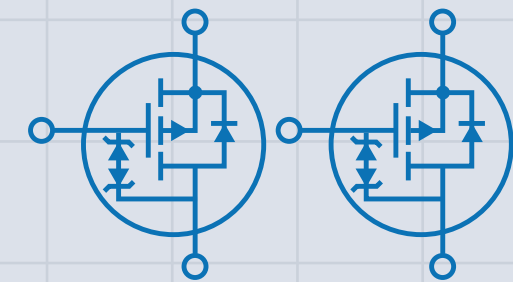

Dual P-Channel

## SPECIFICATION

Part number	Package	Type	Config	$BV_{DS}$ (V)	$I_D$ (mA)	$V_{GS(TH)}$ (V)	$R_{DS(ON)}$ typ( $\Omega$ ) @10V <sub>GS</sub>	$R_{DS(ON)}$ typ( $\Omega$ ) @4.5V <sub>GS</sub>
TQM2N7002KCX	SOT-23	N-MOS	Single	60	370	0.8~2.5	1.2	1.5
TQM2N7002KCU	SOT-323		Single		320	0.8~2.5	1.2	1.5
TQM2N7002KDCU6	SOT-363		Dual		330	0.8~2.5	1.2	1.5
TQM138KCX	SOT-23		Single		360	0.5~1.5	1.2	1.3
TQM138KCU	SOT-323		Single		310	0.5~1.5	1.2	1.3
TQM138KDCU6	SOT-363		Dual		320	0.5~1.5	1.2	1.3
TQM123KCX	SOT-23	P-MOS	Single	100	170	1.5~2.5	3.5	4.3
TQM84KCX	SOT-23		Single	-190	-0.8~-2.5	1.9	2.3	
TQM84KCU	SOT-323		Single	-160	-0.8~-2.5	1.9	2.3	
TQM84KDCU6	SOT-363		Dual	-170	-0.8~-2.5	1.9	2.3	

$V_{GS}(V) \pm 20$

## FEATURES



ADVANCED TRENCH CELL DESIGN



AUTOMOTIVE QUALIFIED  
**AEC-Q101**



MANUFACTURED IN  
**IATF 16949**  
CERTIFIED FACILITIES



ESD PROTECTED  
(HBM  $\geq$  2KV)

## APPLICATIONS

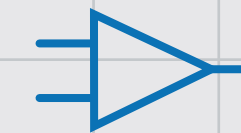

HIGH-SPEED LINE DRIVERS



LOW-SIDE LOAD SWITCHES

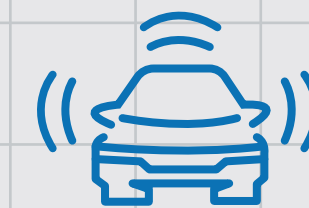

ADAS SYSTEM



IN VEHICLE INFOTAINMENT



SWITCHING CIRCUITS

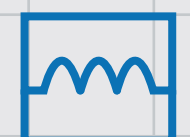

RELAY DRIVER



[www.taiwansemi.com](http://www.taiwansemi.com)